

This is a high-back sling and is designed for use with BHM Medical ceiling and floor lifts. Integral head support is incorporated into the sling design. This sling supports the whole body including the head. It is particularly suitable for people with little control over their head and body.

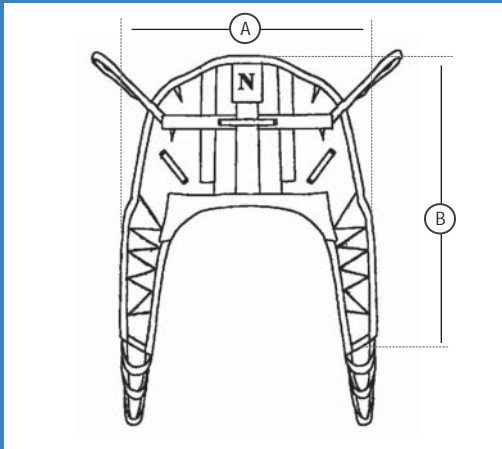

Combi Sling









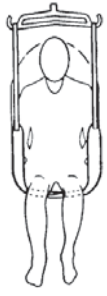

COMBI SLING				
# PRODUCT	DESCRIPTION	DIMENSIONS		
			CM	IN
#62600C	Combi Deluxe - Small Capacity 20-68 kg / 45-150 lb / 3.15-10.71 st	A	79	31
		B	132	52
#626002C-M	Combi Mesh Deluxe - Small Capacity 20-68 kg / 45-150 lb / 3.15-10.71 st	A	79	31
		B	132	52
#626002	Combi Deluxe - Medium Capacity 68-113 kg / 150-250 lb / 10.71-17.86 st	A	91	36
		B	150	59
#626002M	Combi Mesh Deluxe - Medium Capacity 68-113 kg / 150-250 lb / 10.71-17.86 st	A	91	36
		B	150	59
#626003	Combi Deluxe - Large Capacity 113-272 kg / 250-600 lb / 17.86-42.86 st	A	112	44
		B	173	68
#626003M	Combi Mesh Deluxe - Large Capacity 113-272 kg / 250-600 lb / 17.86-42.86 st	A	112	44
		B	173	68

Refer to Sling Operating & Product Care Instructions Guide for complete application details.

# PRODUCT	DESCRIPTION
#62600C	Combi Sling Deluxe - Small
#626002C-M	Combi Sling Mesh Deluxe - Small
#626002	Combi Sling Deluxe - Medium
#626002M	Combi Sling Mesh Deluxe - Medium
#626003	Combi Sling Deluxe - Large
#626003M	Combi Sling Mesh Deluxe - Large

FEATURES	
Warranty against defect	1 year - washable models*
Safe working load	272 kg / 600 lb / 42.86 st
Machine washable	Easy to clean and care for
Head support	Excellent for most general transfer. Suitable for 80% of the people. Ensures that the person is fully supported
Strong nylon/polyester straps with positioning loops	Person can be : <ul style="list-style-type: none"> • seated • semi-reclined • fully reclined
Special leg strap design	Allows the sling to be installed in a variety of methods according to the patients needs.

TECHNICAL SPECIFICATIONS
Conforms to ISO 10535 & Marked CE
*Conditional to normal use and maintenance according to appropriate labels, the sling must be used only with the appropriate BHM Medical Inc. lifting devices.

INSTALLATION OPTIONS				
Bridge, leg closed with straps interlaced	Bridge, legs open with straps not interlaced	Cradled, legs closed	Body position according loop strap color combinations	
			Shoulders	Legs
				
			Yellow	White
				
			Green	White
				
White	Black			
				
White	Orange			