

The Hammock is a total lift sling designed to use with BHM Medical ceiling and floor lifts. The sling provides full head and neck support and double thigh padding for comfort. Quick drying mesh fabric, it is ideal for bathing as well as general transfers. There is a six strap option for use with non-cooperative/agitated persons.

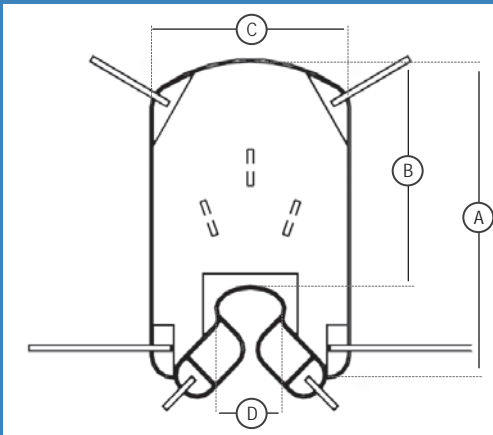

Hammock Sling

HAMMOCK SLING				
# PRODUCT	DESCRIPTION	DIMENSIONS		
			CM	IN
#THA-S	Small Hammock Sling Capacity 20-45 kg / 45-100 lb / 3.15-7.14 st	A	106	42
		B	76	30
		C	66	26
		D	23	9
#THA-M	Medium Hammock Sling Capacity 45-90 kg / 100-200 lb / 7.14-14.29 st	A	124	49
		B	94	37
		C	86	34
		D	28	11
#THA-L	Large Hammock Sling Capacity 90-180 kg / 200-400 lb / 14.29-28.57 st	A	145	57
		B	106	42
		C	96	38
		D	28	11

Refer to Sling Operating & Product Care Instructions Guide for complete application details.





# PRODUCT	DESCRIPTION
#THA-S	Small Hammock Sling
#THA-M	Medium Hammock Sling
#THA-L	Large Hammock Sling

FEATURES	
Warranty against defect	1 year - washable models*
Safe working load	272 kg / 600 lb / 42.86 st
Mesh composition	Soft Polyester
Machine washable	Easy to clean and care for
Leg area	Ultra smooth Nylon/Polyester
Straps	Strong Nylon/Polyester
Patient Body Position	Variable according to loop strap combinations
Weight-distribution inserts	Distributes the weight evenly throughout the sling, no pinching or pressure points
Special leg strap design	Allows the sling to be installed in a variety of methods according to the patients needs.
Strong nylon/polyester straps with positioning loops	Person can be : • seated • semi-reclined • fully reclined
Contoured head support	Excellent for most general transfers. Suitable for 80% of persons. Ensures that the person is fully supported
Rear Positioning handles	• Transfer assistance • Positions the person properly over the chair • Fast and easy transfers from lying position to seated position • Assists the caregiver to rotate the person

TECHNICAL SPECIFICATIONS

Conforms to ISO 10535 & Marked CE

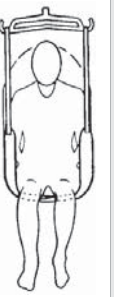
*Conditional to normal use and maintenance according to appropriate labels, the sling must be used only with the appropriate BHM Medical Inc. lifting devices.

INSTALLATION OPTIONS				Body position according loop strap color combinations	
Bridge, leg closed with straps interlaced	Bridge, legs open with straps not interlaced	Independent, legs open	Cradled, legs closed		
				Shoulders	Legs
					
				Black	Blue
				Grey	Blue
				Blue	Blue
				Blue	Grey